

# BRX02 Link Ver. 6x6 Conversion Kit For TRC D110 6x6 Pickup Hard Body #BRX0266100KIT

Difficulty Level: ★★☆☆☆

## INSTALLATION MANUAL

Parts Included:

Parts Numbers:

Qty.

(1)	BRX02-D110 6X6 Extension Rail L	#BRX026601L	1
(2)	BRX02-D110 6X6 Extension Rail R	#BRX026601R	1
(3)	Shock Mount Rear L	#BRX020018R	1
(4)	Shock Mount Rear R	#BRX020018R	1
(5)	Lower Link Mount	#BRX026602	2
(6)	Tapper Spacer D3 x 6 x 3mm	#BRLC7041	2
(7)	M3 x 10 CSS Screw	#BRASFH3010	6
(8)	M3 x 10 RS Screw	#BRASBH3010	2
(9)	M3 x 16 RS Screw	#BRASBH3016	2
(10)	Link - 51.5mm	#BRX026603	4
(11)	D4 x 7 x 2 Spacer	#BRASSPD427/N	10
(12)	M4 x 16 SS Screw	#BRASST4016	8
(13)	M4 Straight Nylon Rod End 18.5mm	#BRW750306A	8
(14)	Pivot Ball	#BRW750300	8
(15)	M3 x 12 RS Screw	#BRASBH3012	4
(16)	M3 x 14 RS Screw	#BRASBH3014	2
(17)	BRX90 Pass-Thru PHAT Axle	#BRX026623	1
(18)	Third Member (A)	#BRX026604	1
(19)	Spacer D3 x D6 x 5mm	#BRLC7040	2
(20)	Ball Bearing 7 x 14 x 3.5mm	#BBZ687OPEN	2
(21)	Ball Bearing 5 x 14 x 5mm	#BBZ6052RS	1
(22)	Ball Bearing 5 x 11 x 4mm	#BBZMR1152RS	1
(23)	6x6 Bevel Spur Gear -Reverse	#BRX026606	1
(24)	Spiral Bevel Gear 8T	#BRX026607	1
(25)	M2.5 x 5 SC Screw	#BRASCH2505	4
(26)	M2.5 x 16 SC Screw	#BRASCH2516	4
(27)	M3 x 20 RS Screw	#BRASBH3020	2
(28)	BRX02 6x6 Final Driveshaft	#BRX026608	1
(29)	Spacer D3 x D6 x 9mm	#BRX026609	2
(30)	M3 x 22 RS Screw	#BRASBH3022	2
(31)	KUDU™ 90mm Coilover Scale Shock Absorbers	#BRSH0090-SP	2

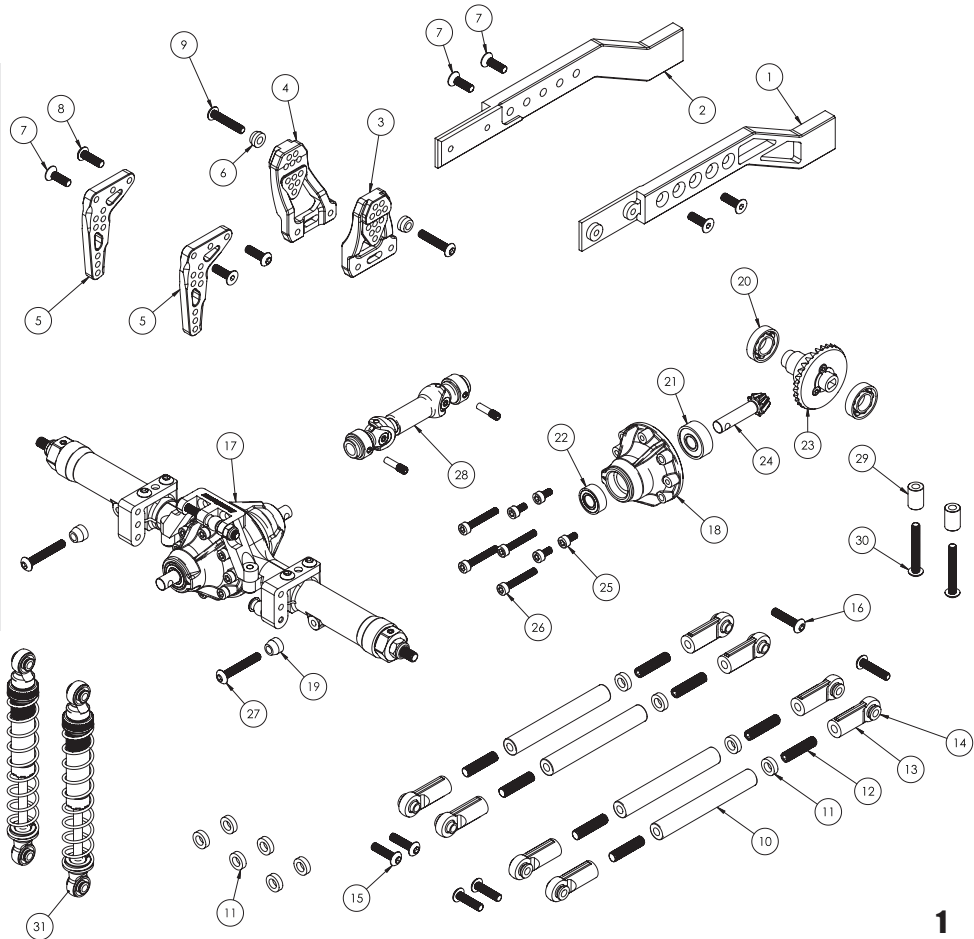

# BRX02 Link Ver. 6x6 Conversion Kit For TRC D110 6x6 Pickup Hard Body #BRX0266100KIT

Difficulty Level: ★★☆☆☆

## INSTALLATION MANUAL

Apply Thread Lock to all screws.  
(Do Not Use Red Loctite)

Begin by removing the BRX02 rear axle, rear bumper mounts, rear bumper, rear crossmember and receiver box.

Next, install the parts as shown.

Tighten all the screws after the rear cross member and rear bumper are both in position.

\*Parts that come with the BRX02 chassis kit are grayed out in this diagram.

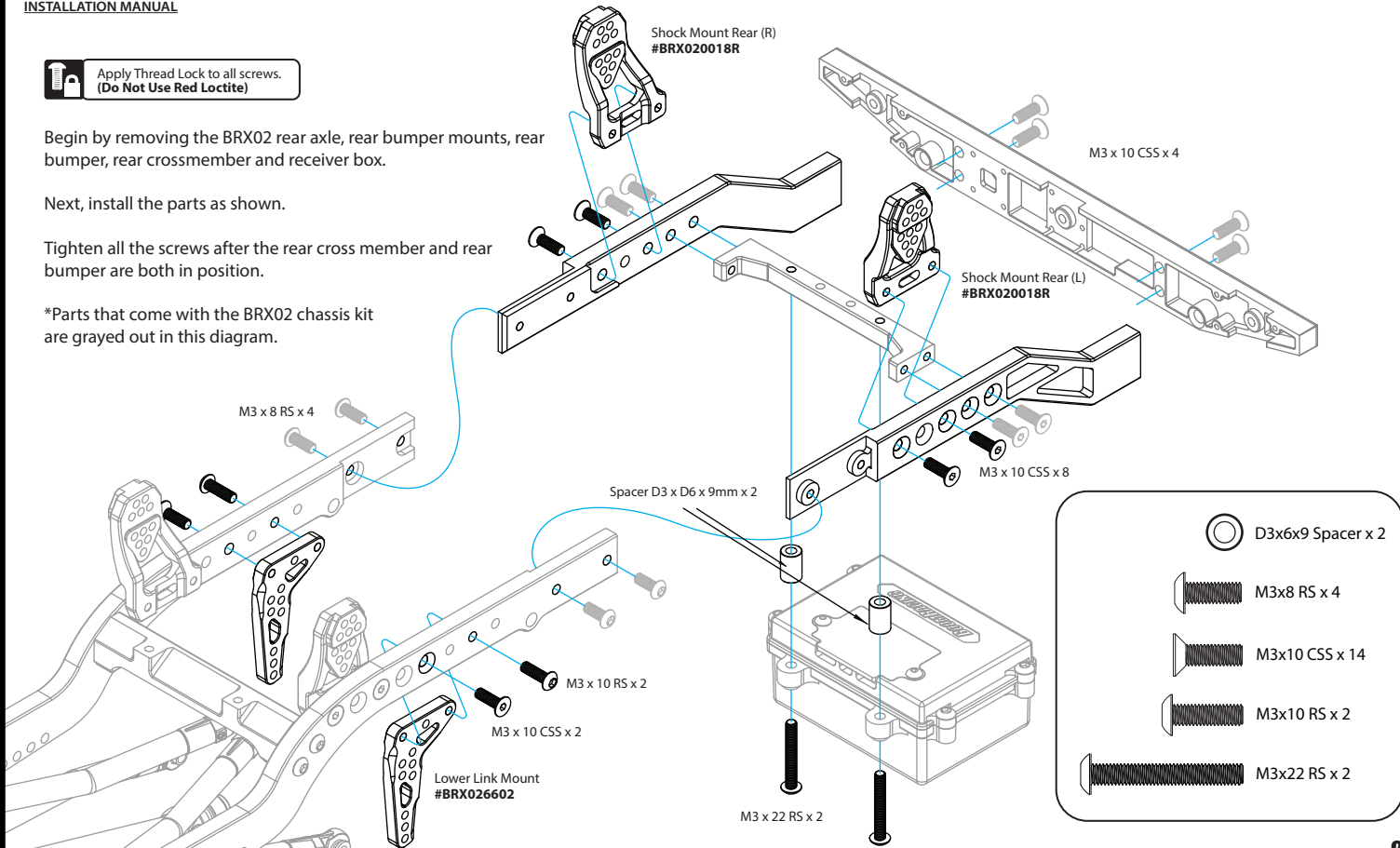

**BRX02 Link Ver. 6x6 Conversion Kit For TRC D110 6x6 Pickup Hard Body #BRX0266100KIT**

Difficulty Level: ★★☆☆☆

**INSTALLATION MANUAL**

Pre-Assembled BRX90 Pass-Thru Axle.

 Apply Thread Lock to all screws.  
**(Do Not Use Red Loctite)**

  
**Black Graphite Grease**  
Apply grease first, then assemble.

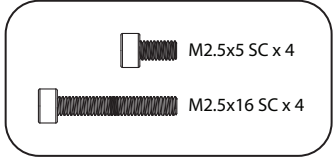
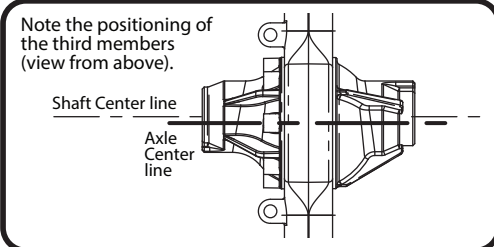
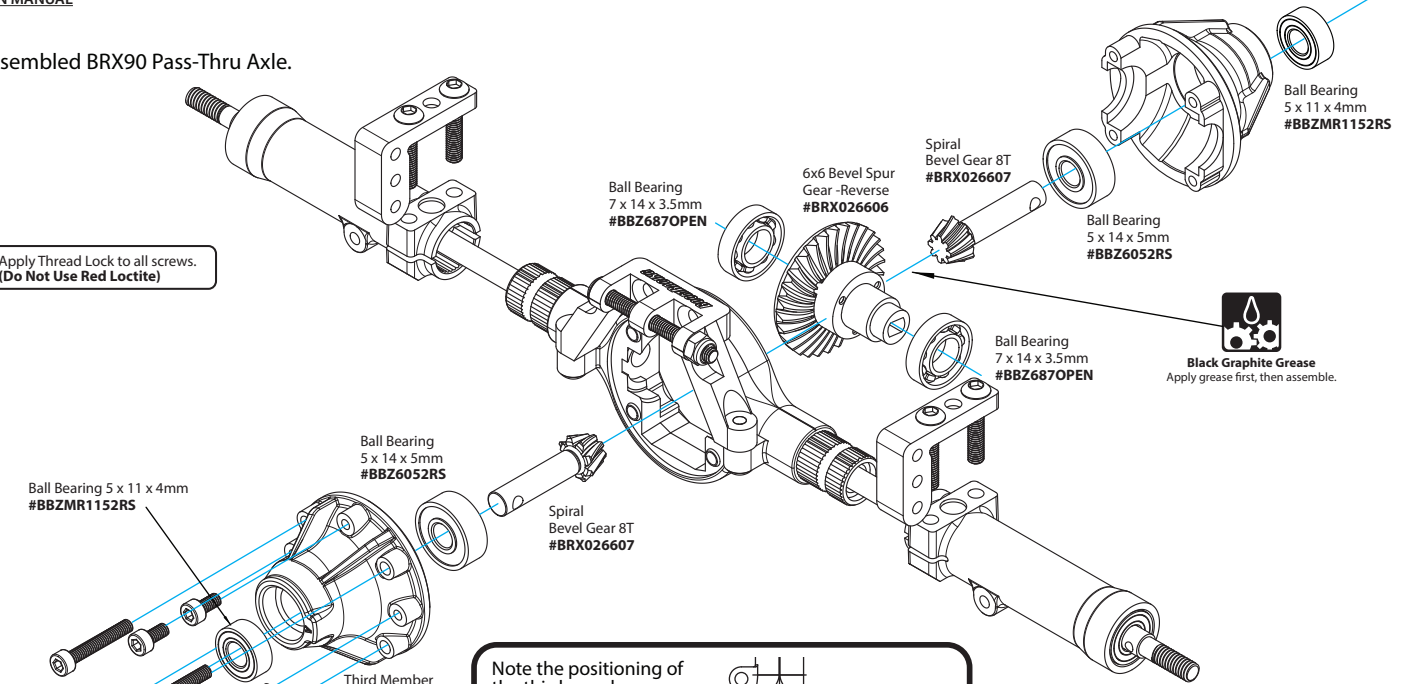

**BRX02 Link Ver. 6x6 Conversion Kit For TRC D110 6x6 Pickup Hard Body #BRX0266100KIT**

Difficulty Level: ★★☆☆☆

**INSTALLATION MANUAL**

New diagram

 Apply Thread Lock to all screws.  
**(Do Not Use Red Loctite)**



**Black Graphite Grease**  
Apply grease first, then assemble.

Ball Bearing  
7 x 14 x 3.5mm  
#BBZ687OPEN

Ball Bearing  
7 x 14 x 3.5mm  
#BBZ687OPEN

Ball Bearing  
5 x 14 x 5mm  
#BBZ6052RS

Spiral  
Bevel Gear 8T  
#BRX026607

Ball Bearing 5 x 11 x 4mm  
#BBZMR1152RS

Third Member  
#BRX026604

M2.5 x 5 SC x 4

M2.5 x 16 SC x 4

The offset shaft is positioned towards the left side of the axle (view from above).

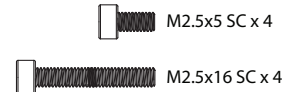
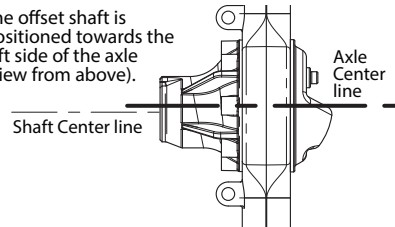

**BRX02 Link Ver. 6x6 Conversion Kit For TRC D110 6x6 Pickup Hard Body #BRX0266100KIT**

Difficulty Level: ★★☆☆☆

**INSTALLATION MANUAL**

 Apply Thread Lock to all screws.  
**(Do Not Use Red Loctite)**

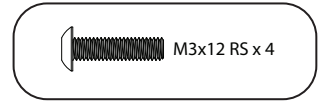
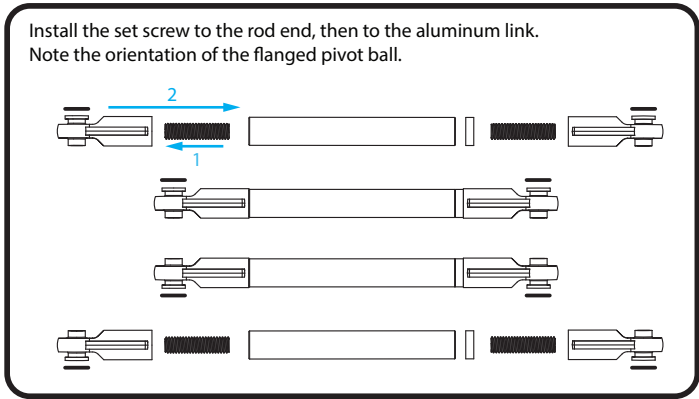
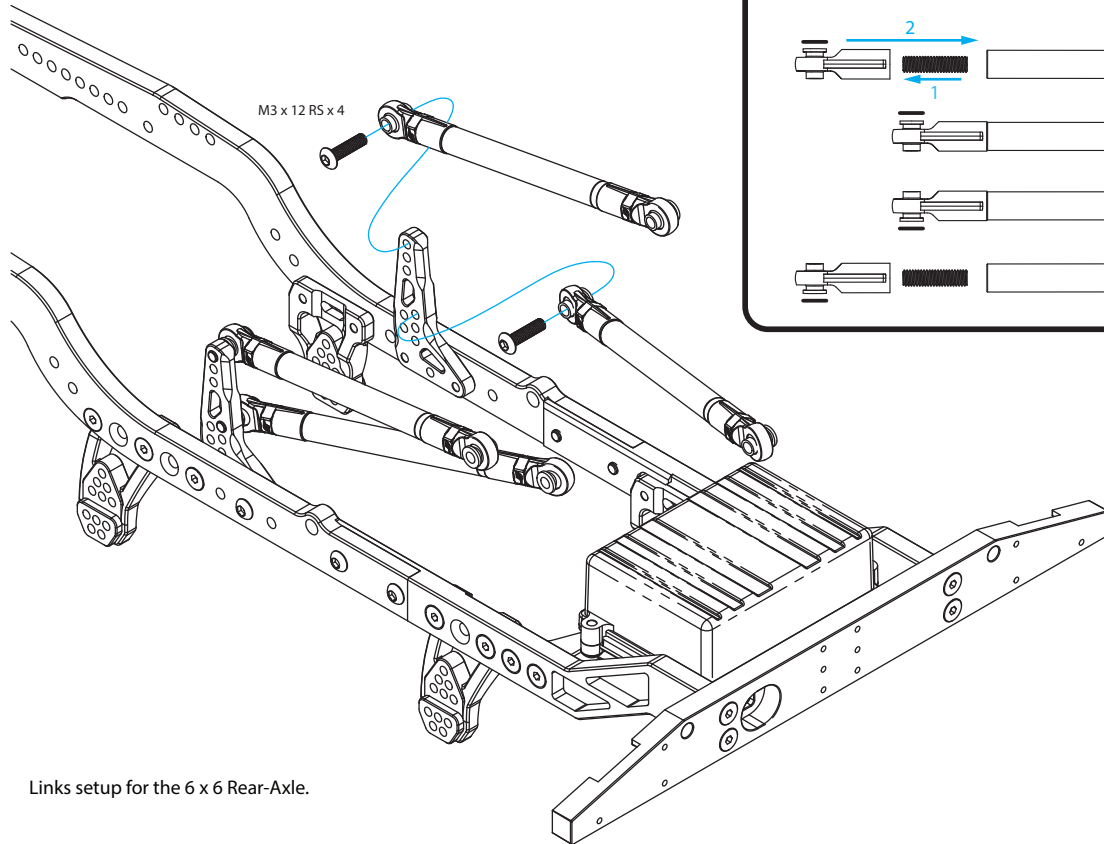

Links setup for the 6 x 6 Rear-Axle.

**BRX02 Link Ver. 6x6 Conversion Kit For TRC D110 6x6 Pickup Hard Body #BRX0266100KIT**





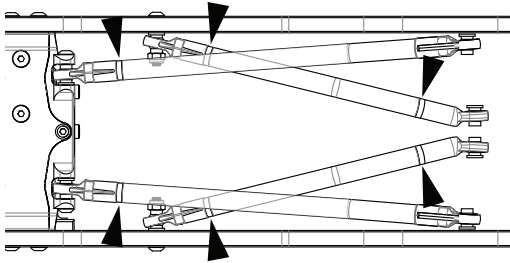

Difficulty Level: ★★☆☆☆

**INSTALLATION MANUAL**

Add two 2mm Nylon Spacers on the upper links for the Pass-through Axle, and keep using one 2mm Nylon Spacer on the lower links.



Install the Pass-Thru PHAT Axle similar to the rear axles of the BRX02. Then, install the rear axle, the center CVD driveshaft and the KUDU shock absorbers.

-  3x6x3 Tapper Spacer x 2
-  3x6x5 Tapper Spacer x 2
-  M3x14 RS x 2
-  M3x16 RS x 2
-  M3x20 RS x 2
-  M3x30 RS x 1

 Apply Thread Lock to all screws.  
**(Do Not Use Red Loctite)**

